

# HAUG Ionization

## How active ionizers function

Steffen Ulrich Homolka  
Diplom-Ingenieur  
HAUG GmbH & Co. KG



Ionizing Systems



# How active ionizers function

Steffen Ulrich Homolka

Diplom-Ingenieur

## Electrostatic charges

The subject of these remarks is what is known as ionizers. Ionizers are associated with static electricity. But how is static electricity defined? It is held to be a static electrical charge. Static electricity can occur in insulators or in conductors which are installed ungrounded.

Static electricity can also be found in nature. A cloud, for instance, can become so statically charged in a storm that there is a discharge towards earth. A discharge can also occur when a positively charged cloud meets a negatively charged cloud. We see these discharge processes as lightning.

Undesirable electrostatic charges can also occur in various manufacturing processes. These physical phenomena can be observed in paper and foil processing, the plastics processing industry, and the textile industry. The major factor influencing the amount of static charge is the electrical conductivity of the material concerned. Other parameters are the speed of processing and the humidity of air.

Static electricity in industrial applications can be reduced or eliminated through increased air humidity, soaking, flame treatment or through ionizers.

Haug specialises in the manufacture of ionization systems and produces devices, in Switzerland and Germany, for eliminating static electricity as well as devices which deliberately charge materials (what are known as charging generators).

## The origin of electrostatic charges

The origin of electrostatic charges used to be explained by friction processes (tribo-electricity).

Today, semiconductor physics puts forward the following theory:

If two materials are brought into close mechanical contact, an electron migration takes place within the common barrier layer because of differing electron work functions. At the common barrier layer, also known as the Helmholtz double layer, a voltage of a few millivolts is produced (Illus. 1).

The barrier layers of both materials can be regarded as a plate capacitor whose voltage  $U$  can be determined through

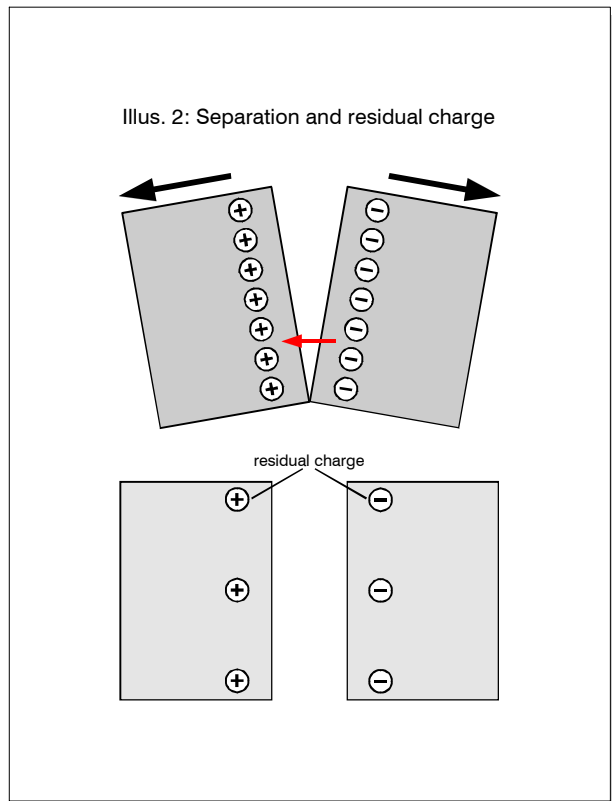
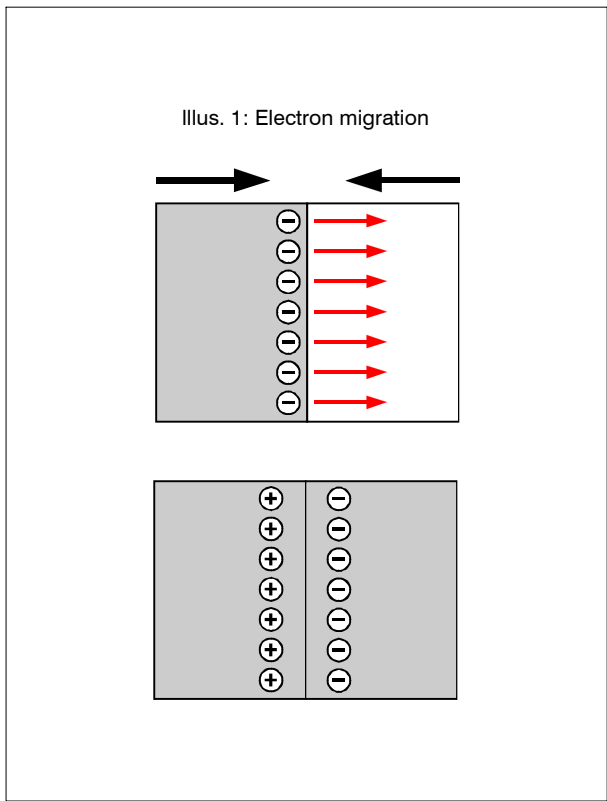
$$U = \frac{Q}{C} \quad (2.1)$$

where  $Q$  is the charge and  $C$  the capacity of the capacitor. On separation of the two workpieces, their distance increases by several orders of magnitude. The capacity of the capacitor reduces correspondingly in accordance with the relationship

$$C = \epsilon_0 \cdot \epsilon_r \cdot \frac{A}{d} \quad (2.2)$$

Here  $\epsilon_0 = (8,859 \cdot 10^{-12} \text{ C}^2 \text{ J}^{-1} \text{ m}^{-1})$  is the dielectric constant and  $\epsilon_r$  the dielectricity of the intermediate layer.  $A$  is the area of the capacitor plates. There is therefore a contact phenomenon. This explains the influence of friction, since the friction influences the size of the contact area.

On separation of the two workpieces, the voltage rises considerably (up to 10 kV and more) if the charge is not balanced (Illus. 2).





## Measuring static electricity

It is possible to measure static electricity indirectly by registering the effects it produces. Nowadays, field strength meters, which use the influence or modulation measuring method, are used. These devices operate without contact and measure the electrical field according to magnitude and polarity.

*Influence measuring sets* measure influence charges, which are generated through the effect of the electrostatic field of a charged body.

*Modulation measuring units* use mechanical modulation to convert the electrostatic field, which is constant over time, into a periodic quantity which is measured. This is the principle under which the rotary voltmeter, also called Feldmühle (field mill), works. In the rotary voltmeter a capacity is modulated through a rotating wing. We know from

$$Q = C \cdot U \quad (3.1)$$

that the charge  $Q$  of a plate capacitor is proportional to the voltage  $U$  applied to the capacitor, where  $C$  is the capacity of the capacitor.

If equation (3.1) is differentiated according to time, we obtain

$$\frac{dQ}{dt} = i = \frac{dC}{dt} \cdot U + C \cdot \frac{dU}{dt} \quad (3.2)$$

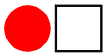
At the capacitor the applied voltage  $U$  is related to the electrical field strength  $E$  of the field between the plates through the equation

$$U = E \cdot d \quad (3.3)$$

where  $d$  is the distance between the plates. At a constant voltage, (3.2) and (3.3) tell us that

$$i = \frac{dC}{dt} \cdot E \cdot d \quad (3.4)$$

The current  $i$  flowing (and modulated) through the modulated capacity is therefore proportional to the field strength  $E$ .



## Interference caused by electrostatic charges

In the textile industry, electrostatic charges are undesirable for a variety of reasons:

### Bobbin creel

High electrostatic charges occur here when the thread is separated from the bobbin. Additional static electricity is produced when the thread is passed through guide eyelets. The charged material attracts particles of dirt from the environment. Threads charged with the same sign repel each other, and threads with opposing polarity attract each other. The threads flutter and the result is increased thread breakage.

### Take-off device

A statically charged fabric web can only be taken off unevenly. The forces caused by charges can lead to the fabric winding itself round rolls and rollers.

### Operating personnel

People who approach electrostatically charged fabric can experience very unpleasant electrical shocks.

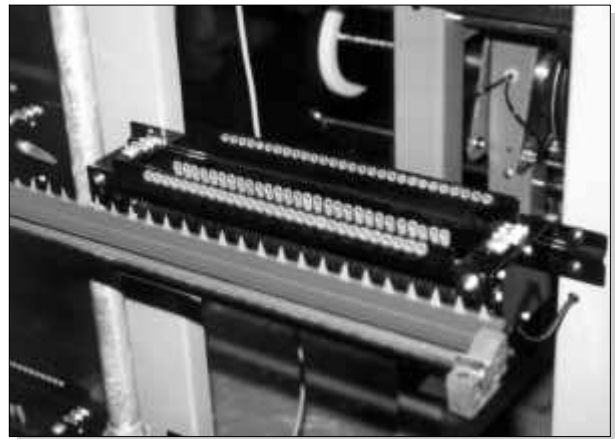


Fig. 1: Works illustration, passive ionizer on a warping machine



## Ionizers

Ionizers generate ions, which are electrically charged atoms and molecules. In an electrically neutral atom, the number of protons in the atom nucleus is identical to the number of electrons in the atom shell. In an ion, by contrast, the number of electrons is increased or reduced. Since the electrons carry the negative charge, a negative ion is produced if the number of electrons in the atom shell rises.

A positive ion has one or more electrons less than a corresponding electrically neutral atom.

Gaseous constituents of air are ionized. Solid particles and vapour in the air are charged.

Ionizers come in all shapes and sizes. The most frequently used ionizers are bar-shaped.



Fig.: 2 HAUG high-voltage power pack and ionizing bar



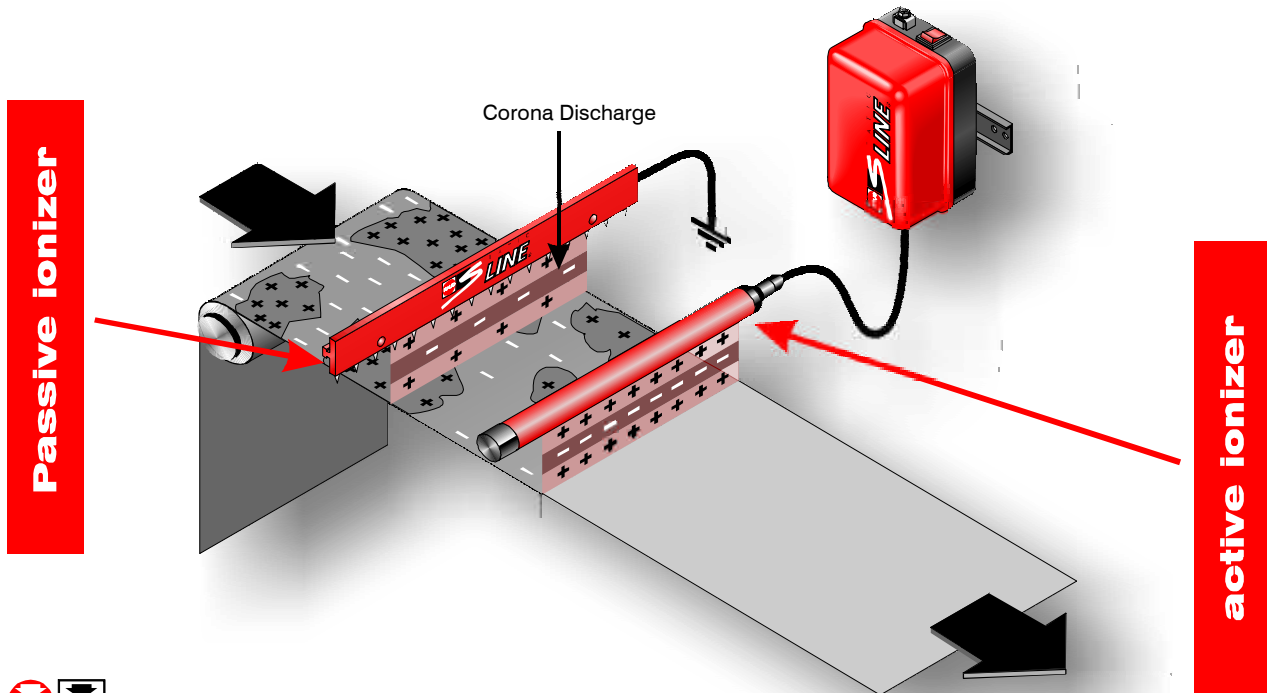
### Passive ionizer

Passive ionizers are constructed such that metallic tips are connected with the earth. If such an ionizer is brought near a charged material, a corona discharge is induced in the pins of the ionizer, thereby generating ions.

The effect of passive ionizers is limited. In general, they are only employed in combination with active ionizers.

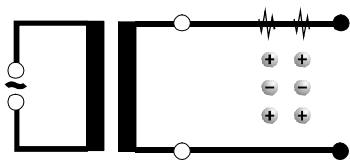


Fig. 3: Passive ionizer



### Active ionizers

Active ionizers are manufactured according to various design principles. Alternating current devices are the most commonly used. Haug voltage generators operate at system frequency (50 Hz) and generate a voltage of approx. 7 kV.



Illus. 3: Principle of an active ionizer

In ionizing bars, high voltage is fed to multiple pins. With HAUG ionizing bars, the pins are not connected directly to the high voltage, but are galvanically separated from it. This makes HAUG ionizing bars safe to touch. Positive and negative ions are generated at each pin in phase with the system frequency (Illus. 3); positive ions in the positive half-wave of the alternating current, negative ions in the negative half-wave. These ions neutralize charges which are located on a material below the ionizing bar, since the ions of opposing polarity are attracted. Redundant ions flow over the sheath of the bar to the earth. This means that no undesirable charges are accommodated. An active ionizer of the type described is therefore self-regulating.

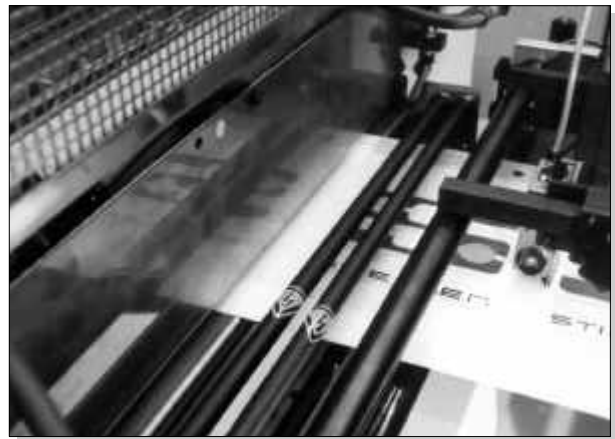


Fig. 4: Active ionizer on an automatic bag forming, filling and sealing machine.



## Air-assisted active ionizers

Ionizers of the kind described in the preceding section have an inherent disadvantage in that their range is relatively narrow (10 mm up to max. 200 mm). Since ions of both polarities are generated, the ions generated recombine at a certain distance from the ionizer. The ions are therefore neutralized at a greater distance. This phenomenon can be reduced by conveying the ions away from the ionizer using compressed air. In this way the effective range of an ionizer can be increased up to a maximum of approx. 70 cm.

Compressed air is predominantly used when a surface is to be cleaned. The ionized compressed air is particularly effective at detaching particles of dust and dirt. The ionization eliminates the electrostatic forces binding the particles to the surface.

HAUG offers air-assisted ionizers in a wide variety of forms. There are ring-shaped air-assisted ionizers for manual operation and for stationary installation. Also available are bar-shaped ionizers which can be complemented by an blast-air strip, or combined with a pipe fitted with nozzles.



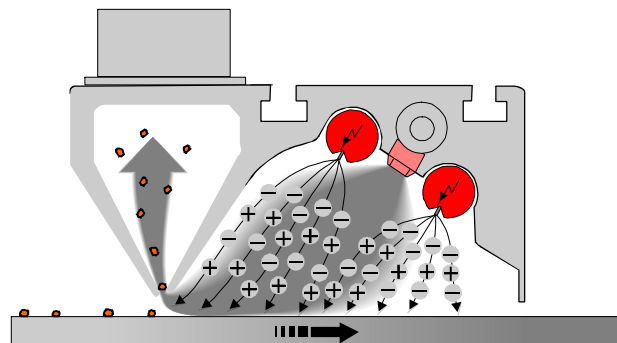
Fig. 6: HAUG ionizing bar, combined with air-assisted "Jet Streamer" for the removal of dust from surfaces and for the transport of generated ions to greater distance.



Fig. 5: HAUG needle ionizer with suction-blower system for bottle cleaning

## Bibliography

- Gärtner, R.: *Elektrostatische Aufladung und Entladung*  
Universität der Bundeswehr München, 1991
- Gerthsen, Kneser, Vogel: *Physik*  
Springer-Verlag Berlin, Heidelberg, New York, 14. Auflage 1982
- Lüttgens, G., Glor, M.: *Elektrostatische Aufladungen begreifen und sicher beherrschen*, Expert-Verlag, 2. Auflage, 1988



Illus.4: HAUG Statik-Air, System Dr. Escherich, for the removal of dust from webs and plates.



## Material web cleaners

The modern paper, cardboard, and textile processing industries are placing increasing demands on the cleanliness of materials. This is particularly the case when the material web is to be carried to further processing and when the quality requirements are high.

In such cases web cleaning systems are used. Web cleaners combine various techniques. The aim is to remove fibres, powder and dust from the web. The particles adhering to the surface of the material are raised through the ionized blown air and subsequently sucked off. Rotating brushes are also sometimes used additionally to remove dirt.

HAUG offers various web cleaning systems with a suction width from 30 cm to 2 m. Illus. 4 shows a web dedusting device fitted with two ionizing bars. A jet of air flowing between the bars conveys the positive and negative ions to the surface of the material at an angle. The air whirl containing the particles of dust is sucked off where the ion jet meets the surface.

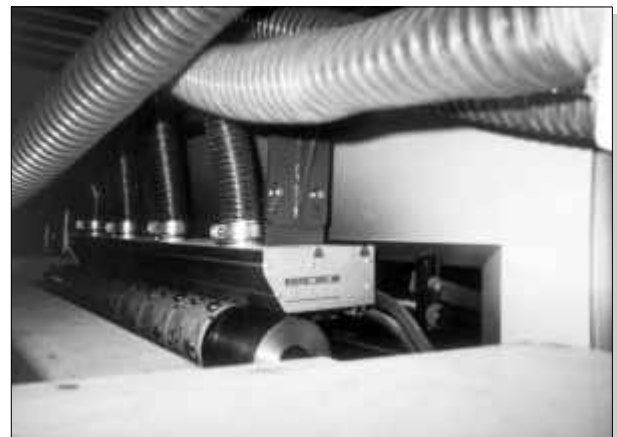


Fig.7: Factory illustration





**HAUG GmbH & Co. KG** **Germany**

Friedrich-List-Str. 18  
D-70771 Leinf.-Echterdingen  
Phone: +49 711 / 94 98-0  
Telefax: +49 711 / 94 98-298

[www.haug.de](http://www.haug.de)  
E-mail: [info@haug.de](mailto:info@haug.de)

**HAUG Biel AG** **Switzerland**

Johann-Renfer-Str. 60  
CH-2500 Biel-Bienne 6  
Phone: +41 32 / 344 96 96  
Telefax: +41 32 / 344 96 97

[www.haug-ionisation.com](http://www.haug-ionisation.com)  
E-mail: [info@haug-biel.ch](mailto:info@haug-biel.ch)

**HAUG North America** **Canada**

Limited Partnership  
1200 Aerowood Drive, Units 14 & 15  
Mississauga, ON L4W 2S7, Canada  
Phone: +1 905 / 206 97 01  
Telefax: +1 905 / 206 08 59

[www.haug-static.com](http://www.haug-static.com)  
E-mail: [info@haug-static.com](mailto:info@haug-static.com)